



Desktop 2.4G Laser Mouse

RF-MSE12

User Guide

Rocketfish RF-MSE12 Desktop 2.4G Laser Mouse

Contents

Introduction	2
Features.....	2
Setting up the mouse	5
Using the mouse.....	10
Using the Mouse Suite software	12
Troubleshooting	25
Legal notices	26
One-Year Limited Warranty.....	29

Introduction

Congratulations on your purchase of the RocketFish Desktop 2.4G Laser Mouse. Your mouse features an innovative tilt scroll wheel that allows you to scroll windows up and down and side-to-side. The smooth navigation is a more efficient way to navigate through your documents and web pages.

Features

Laser mouse features

Your optical mouse features the following:

- Tilt scroll wheel
- Five programmable buttons

- Resolution setting button
- Power saving mode
- LED indicator

Slim USB receiver

- 2.4GHz technology

System requirements

- USB mouse supported computer
- Microsoft Windows 2000/XP/Vista or later

Software features

- Windows 2000/XP/Vista compatible
- Mouse Suite for configuring and managing mouse settings.

Package contents

Before you start using the mouse, verify that the following items are in your package. If anything is missing, contact your retailer.

- Laser mouse
- (Slim) USB receiver
- Two AA batteries
- CD
- User guide

Identifying components

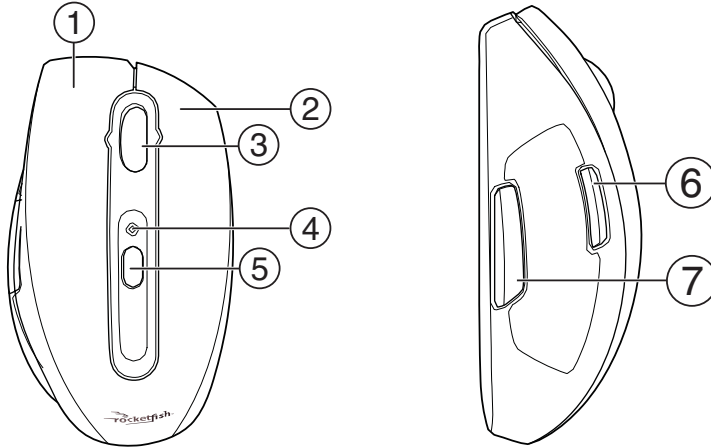

Item	Description
1	Left button
2	Right button
3	Tilt/scroll wheel button
4	Status LED
5	Resolution button
6	Programmable button A
7	Programmable button B

Identifying status indicators

The following table describes the status indicators on the mouse and receiver.

LED	Color	Description
Mouse	Green	Mouse is turned on, battery level normal (illuminates for 5 seconds).
	Red	Low battery (flashes for 1 minute).
USB Receiver	Green	Wireless connection active and operating correctly (lit when mouse is in use).
	Red	Connection in progress (flashing).

Setting up the mouse

Installing the batteries

The mouse uses two AA size batteries. Complete the following steps to install the batteries.

To install the batteries:

- 1 Push the tab to release the battery cover.

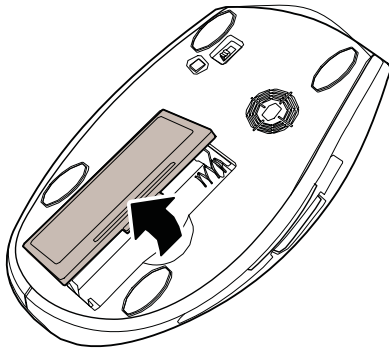

- 2 Install two AA batteries observing the polarity (+ and -) indicated inside the housing.

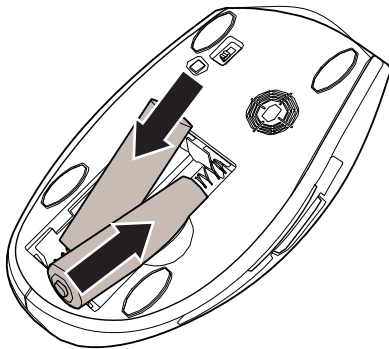

- 3 Replace the battery cover.

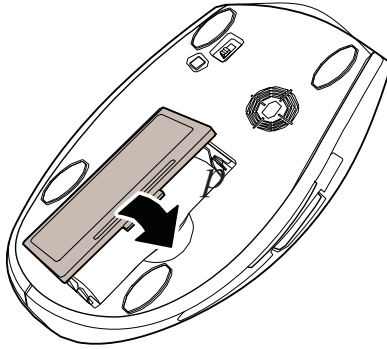

Installing the Mouse Suite software

Complete the following steps to install the Mouse Suite software on your computer.

To install the Mouse Suite:

- 1 Insert the USB receiver into an available USB jack on your computer.
- 2 If this is the first time you have connected the USB receiver to your computer, the *Found New Hardware Wizard* starts automatically. Cancel the Wizard, then follow the steps below.
- 3 Insert the provided CD into your computer's CD or DVD drive. The software starts automatically.

If the software does not start automatically, double-click **Setup.exe** located in the **bin** folder on the CD.

The *Welcome* screen opens.

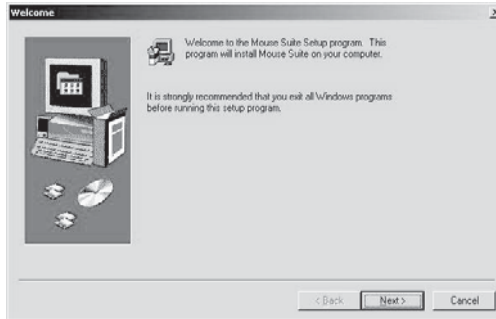

4 Click **Next** to continue. The *Start Installation* screen opens.

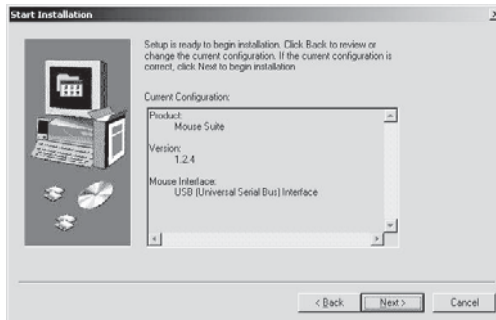

- 5 Click **Next**. The program takes a few moments to install. When the program is installed, the *Setup Complete* screen opens.

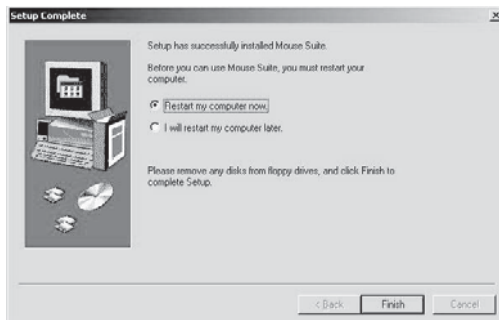

- 6 Click **Finish**.

Note: You must reboot your computer before using the Mouse Suite.

Connecting the mouse

Connecting the mouse to a PC

After you install the batteries and the Mouse Suite software, your mouse is ready to use.

To connect the mouse to a PC:

- 1 Make sure that the USB receiver is inserted into an available USB jack on your computer.

- Slide the mouse power switch to the **on** position.

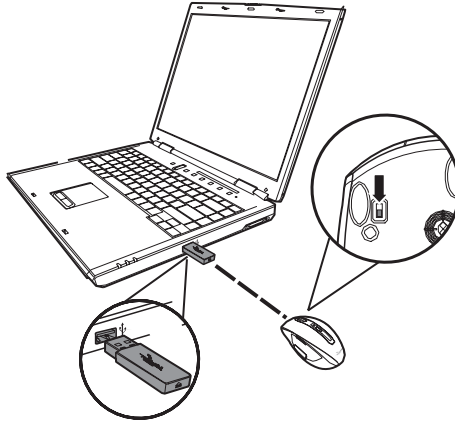

- Move the mouse to verify that it is connected.
- If the mouse does not respond, press and hold the **Pairing** button until the LED flashes every second. This indicates the dongle has started to search for the device to be paired.

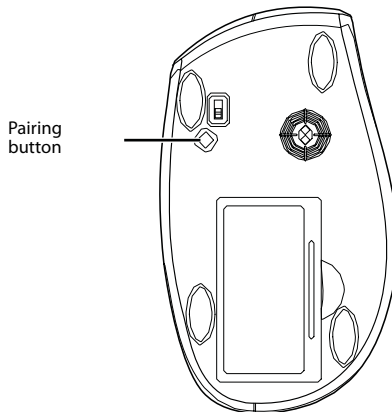

Note: Each time you turn on your computer, the mouse is automatically detected.

Turning on the USB mouse function in BIOS

If the mouse fails to work, verify that the keyboard/mouse USB function has been turned on in the BIOS. See your computer user guide for more information.

Note: Some older PCs do not support the USB keyboard/mouse in BIOS/DOS environment.

Using the mouse

Note: The scroll wheel on the mouse is automatically disabled while the mouse is pairing.

Note: The mouse enters a power-saving mode when not in use for a period of time.

Using the mouse status indicator

The Laser Mouse has a battery status LED. When the battery is low, the LED flashes red for one minute. You should change the batteries immediately.

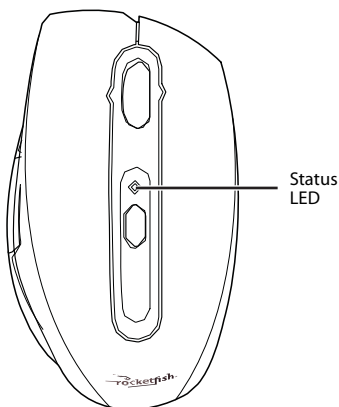

Changing the mouse resolution

Your mouse can operate in resolutions of 800 dots per inch (dpi) or 1600 dpi. Push the Resolution button to toggle between resolutions. A higher resolution is more accurate but may be more difficult to control.

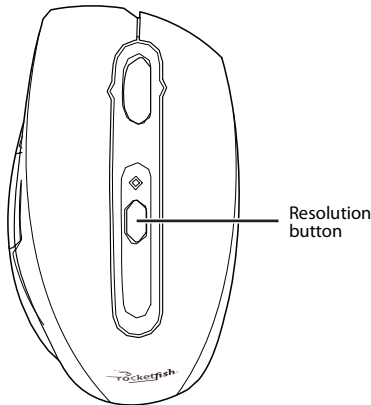

Note: We recommend you use higher resolutions for gaming and lower resolutions for normal operation.

Using the User Configurable Buttons

There are two mouse buttons located on the left side of the mouse. Both can be configured to perform user-defined functions. For a list of available functions, see *Configuring the mouse buttons* on page 13.

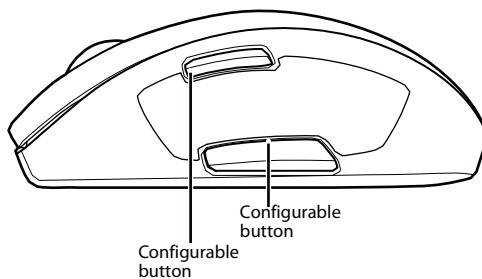

Using the Mouse Suite software

Starting Mouse Suite

To start using Mouse Suite:

- Double-click the Mouse icon in the system tray or right-click the icon to open the context menu, then click **Adjust Mouse Properties**.



Or, if the mouse icon is not in your system tray, click **Start > Settings > Control Panel > RocketFish** to start using the software.

Using the Mouse Suite system tray icon

The mouse icon in the system tray indicates the USB receiver and mouse are connected.

- A red icon indicates the mouse battery is low.



- A white icon indicates the battery is ok.



Using the Mouse Suite dialog box

The Mouse Suite dialog box is divided into six tabs. Click each tab to view related settings.

Under each tab there are three common buttons:

- Click **OK** to save your settings and close the dialog box.
- Click **Cancel** to exit the dialog box without saving.

- Click **Apply** to have your changes take effect without closing the dialog box.

Configuring the mouse buttons

Click the **Buttons** tab to view an image of your mouse and a description of button functions.

To assign functions to each of the buttons (method 1):

- 1 Click the drop-down menu next to the button you want to customize in the button overview screen.
- 2 Select the function you want to assign to the button from the list.
- 3 Click **Apply** to start using this function or **Cancel** to exit the Mouse Suite without making changes.

To assign functions to each of the buttons (method 2):

- 1 Click the **Button** drop-down menu. Select the button you want to customize from the list.
- 2 Click the **Function** drop-down menu. Select the function you want to assign to the button from the list.
- 3 Click **Apply** to start using this function or **Cancel** to exit the Mouse Suite without making changes.

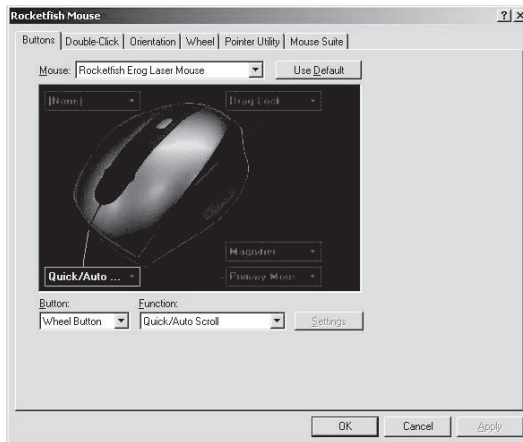

The fields or buttons on this screen include:

Field/Button	Description
Mouse	Select your mouse from a list of compatible devices.
Use Default	Click this button to return the settings on this screen to factory defaults.
Button	Select the button you are configuring. See <i>Assigning functions to the mouse buttons</i> on page 14 for a list of functions and their descriptions.
Function	Select the function you are assigning to the button.
Settings	Click this button to edit the setting. This button is only available when the selected function has a configurable setting.

Assigning functions to the mouse buttons

You can assign one of the following functions to each button on your mouse.

Function	Description
Primary Mouse Button (Standard left-click)	Functions as the primary mouse button for selecting and dragging.
Context Menu (Standard right-click)	Opens the context menu.
Back	Move to previous page.
Forward	Move to next page.
Next Window	Makes the next window active.
Close Window	Closes the active window.
Maximize Window	Maximizes the active window.
Minimize Window	Minimizes the active window.
Quick/Auto Scroll	Scrolls the page up and down when held and the mouse is moved.
Copy (Ctrl+C)	Copies the selected item or text to the clipboard.
Cut (Ctrl+X)	Cuts the selected item or text to the clipboard.
Undo (Ctrl+Z)	Undo the previous action.
Redo (Ctrl+Y)	Redo the previous action.
My Computer	Opens the <i>My Computer</i> window.
Enter	Emulates pressing the Enter key.
Escape	Emulates pressing the Escape key.
Tab	Emulates pressing the Tab key.
Shift	Emulates pressing the Shift key.

Function	Description
Alt	Emulates pressing the Alt key.
Ctrl	Emulates pressing the Ctrl key.
Delete	Emulates pressing the Delete key.
Backspace	Emulates pressing the Backspace key.
Save	Saves the current document or file.
Start Button	Opens the Windows Start menu.
Web Browser	Opens your default web browser.
Windows Explorer	Opens <i>Windows Explorer</i> .
Control Panel	Opens the <i>Control Panel</i> .
Printers	Opens the <i>Printers</i> window.
HyperGrid	Opens a menu with access to nine most commonly performed actions. See Using the HyperGrid function on page 15 for details.
Double-click	Performs a double-click action.
Drag Lock	Pressing the button enables the drag lock feature of the primary mouse button. Pressing again disables drag lock.
Hyperlink	Opens a specified program. See Using the Hyperlink function on page 16 for details.
Magnifier	Enables the Magnifier function. See Using the Magnifier function on page 17 for details.

Using the HyperGrid function

The HyperGrid function, when assigned to one of the buttons on your mouse, opens a menu with easy access to nine of the most commonly used functions.

To use the HyperGrid function:

- 1 Assign **Hyperlink** to one of the buttons.

- 2 Click and hold the button to open the menu.

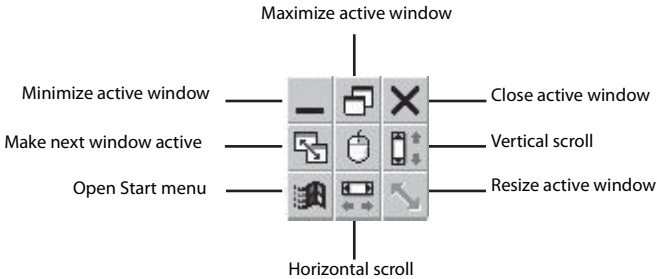

- 3 Move the pointer to the function you need.
- 4 Release the button to select the function.
- 5 Press the button again to exit the selected function.

Using the Hyperlink function

The Hyperlink function, when assigned to one of the buttons on your mouse, opens up a specified program.

To use the Hyperlink function:

- 1 Assign **Hyperlink** to one of the buttons.
- 2 Click **Settings**. The *HyperLink* dialog box opens.

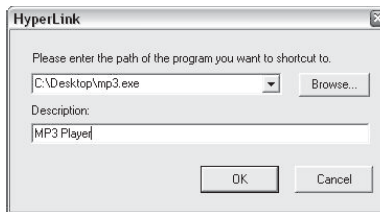

- 3 Enter the path to the program or browse for the program you want to open.
- 4 Enter a description (optional).
- 5 Click **OK**, then click **Apply** on the main screen.
- 6 When you click the assigned button, the program you have specified loads.

Using the Magnifier function

The Magnifier is a unique feature of the mouse. It allows you to zoom in on a specific area of the screen for viewing in closer detail.

To use the Magnifier function:

- 1 Check the **Magnifier** checkbox.
- 2 Assign **Magnifier** to one of the buttons.
- 3 Click **Apply** to have your changes take effect.

Using the button default settings

Each button is assigned a default function.

Button	Description
Left	Primary Mouse Button
Right	Context Menu
Wheel	Quick/Auto
Scroll Button A	Back
Button B	Forward

To restore these default functions at any time, click **Use Default**.

Changing the double-click speed

Many items in Windows require that you click the left mouse button twice in quick succession to be activated. This is called a *double-click*.

If you experience difficulty double-clicking on items, this may be because the time in which you have to perform two clicks of the left mouse button is too short.

To change the double-click speed:

- 1 Click the **Double-Click** tab.

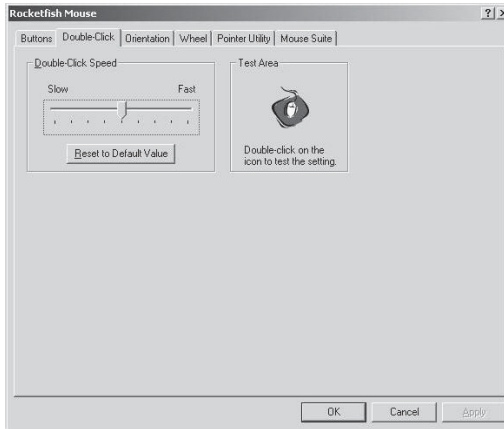

The fields or buttons on this screen include:

Field/Button	Description
Double-Click Speed	Click and drag this slider towards Slow or Fast to set the double-click speed.
Reset to Default Value	Click this button to return the double-click speed to the original value.
Test Area	Double-click this icon to test the double-click speed. If successful the icon animates. If the icon does not animate, adjust the Double-Click Speed .

- 2 Slide the double-click slider to set the delay between clicks for which a double-click is registered.
- 3 Double-click on the icon in the test area. If the icon does not animate, you need to slow down the double-click speed.

Setting the orientation

You can set the angle at which you hold your mouse.

To set the orientation:

- 1 Click the **Orientation** tab.

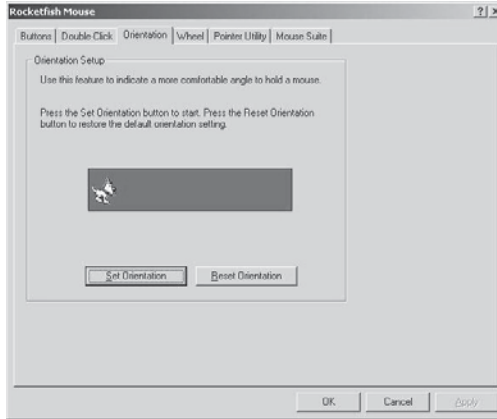

The fields or buttons on this screen include:

Field/Button	Description
Set Orientation	Hold the mouse at the desired angle of use, then click this button. Now move the mouse to your right and make the animated dog run across the screen. The mouse orientation is now matched to the angle at which you held the mouse.
Reset Orientation	Click this button to return the mouse orientation to its default setting.

Setting the tilt scroll wheel

Your mouse comes with an advanced scroll wheel that enables both horizontal and vertical window scrolling. You can configure how the scroll and tilt wheel on your mouse is used in the Windows environment.

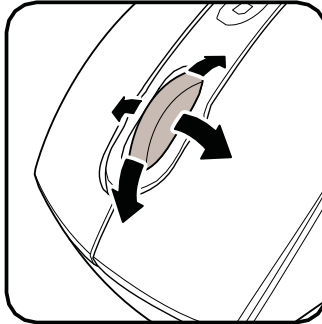

To configure the tilt scroll wheel:

- 1 Click the **Wheel** tab.

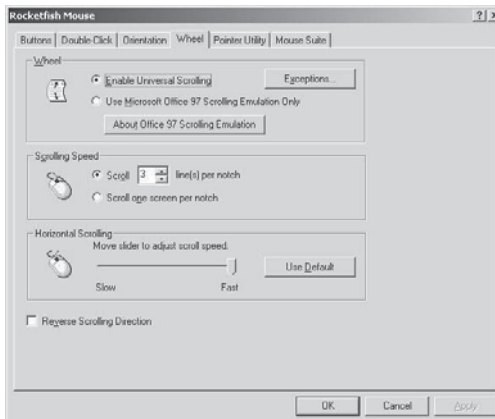

- 2 Modify the settings. Descriptions of the settings appear on the following pages.

Setting wheel scrolling

You can choose to enable *Universal Scrolling* or *Microsoft Office 97 Emulation Scrolling*.

To select the type of wheel scrolling:

- 1 Select **Enable Universal Scrolling** or **Use Microsoft Office 97 Scrolling Emulation only**.

Selection	Description
Universal Scrolling	Select to enable scrolling in all applications, not only those that support IntelliMouse functionality.
Microsoft Office 97 Scrolling Emulation	Select to enable scrolling in older applications that are only Office 97 compatible.

- 2 If you select universal scrolling, click **Exceptions** to configure applications that use Microsoft Office 97 scrolling.
- 3 Click **Apply** to have your changes take effect.

Exceptions

You can select applications that use Microsoft Office 97 Scrolling Emulation regardless of whether universal scrolling is enabled.

To select applications using Microsoft Office 97 scrolling:

- 1 Click the **Exception** button in the **Wheel** tab. The *Exceptions* dialog box opens.

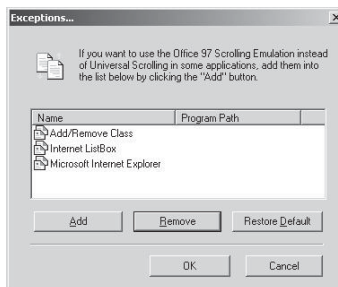

- 2 Select an application in the list to be removed, then click **Remove** to delete that application.

Or, click **Add** to add an application. The *Add Exception Application* dialog box opens.

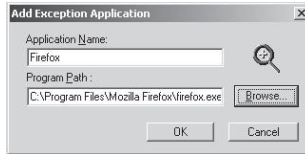

- 3 Click **Browse** to browse to the application to add to this list, then click **OK**.
- 4 Click OK to close the *Exceptions* dialog box.

Assigning a function to the wheel button

You can assign a separate function to the wheel button itself, apart from the scroll function.

To assign a function to the wheel button:

- 1 Select **Quick/Auto Scroll Control** or **Button Function**.

Selection	Description
Quick / Auto Scroll Control	Select to enable the button to act as a scroll speed control when pressed.
Button Function	Select and choose a function from the drop-down menu to assign to the wheel button.

- 2 Click **Apply** to have your changes take effect.

Setting the scroll speed

You can specify the speed at which the window scrolls when using the scroll wheel.

To set the scrolling speed:

- 1 Select **Scroll x lines per notch** or **Scroll one screen per notch**.

Selection	Description
Scroll x lines per notch	Select to set the number of lines to scroll when the scroll wheel is moved one notch. Specify the number of lines with the up and down arrows.
Scroll one screen per notch	Select to scroll the entire window when the scroll wheel is moved one notch (page up/page down).

- 2 Click **Apply** to have your changes take effect.

Changing the pointer

You can configure additional pointer functionality.

To change the pointer:

- 1 Click the **Pointer Utility** tab.

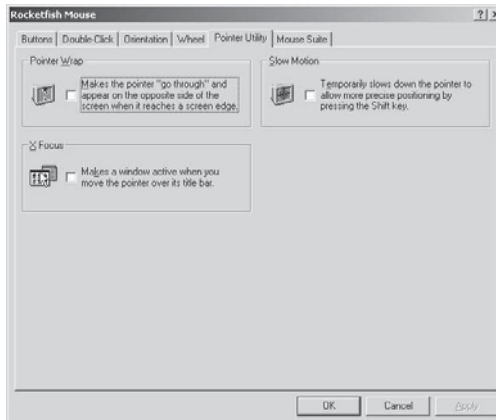

The fields or buttons on this screen include:

Field/Button	Description
Pointer Wrap	Enable this function to allow the pointer to exit one side of the screen and appear on the opposite side.
Slow Motion	Enable this function to have the pointer slow down when the Shift key is held down.
X Focus	Enable this function to make the window under the pointer the active window.

- 2 Select the function(s) to apply to the pointer.
- 3 Click **Apply** to have your changes take effect.

Configuring the Mouse Suite settings

You can add the Mouse Suite icon to the system tray and uninstall the Mouse Suite software using the Mouse Suite tab.

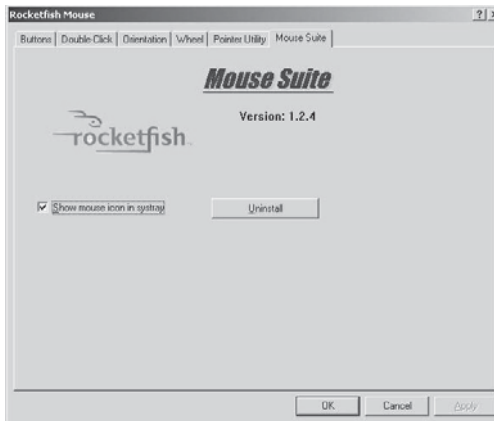

Adding the Mouse Suite icon to the system tray

To show the Mouse Suite icon on the system tray:

- 1 Click the **Mouse Suite** tab.
- 2 Check **Show mouse icon in systray** to display the icon in the system tray.
- 3 Click **Apply** to have your changes take effect.

Uninstalling the Mouse Suite

To uninstall the Mouse Suite:

- 1 Click the **Mouse Suite** tab.
- 2 Click **Uninstall**. A confirmation message displays.
- 3 Click **Yes** to uninstall or **No** to cancel.

Troubleshooting

If you have any problems with your mouse, complete the following:

- Check the system requirements to make sure that your system is compatible.
- Check to see if the batteries in the mouse are installed correctly. Make sure the polarity of the batteries corresponds with the polarity signs inside the mouse battery compartments.
- Check the mouse LED. If it glows red, it indicates the battery power is low. Replace the old batteries with new batteries immediately.

Once the Mouse Suite (see Installing the Mouse Suite software on page 6) is installed on your computer, the battery status of your mouse is displayed by moving the mouse over the mouse icon in your system tray. See Using the Mouse Suite system tray icon on page 12.

- Check the USB mouse function in your system's BIOS if the mouse fails to work. The function should be enabled for normal use.

If your PC BIOS setup has mouse options, make sure they are set to default settings. If you are not familiar with the BIOS, refer to your PC's manual for more information.

- Use the mouse on a clean, flat, non-slippery surface in order to ensure smooth and accurate cursor action. If you use a mouse pad, darker colors require more battery power.
- Contact your dealer for support with any other questions you may have.

Legal notices

FCC Part 15

This device complies with Part 15 of the FCC Rules. Operation of this product is subject to the following two conditions: (1) this device may not cause harmful interference, and (2) this device must accept any interference received, including interference that may cause undesired operation.

This equipment has been tested and found to comply within the limits for a class B digital device, pursuant to Part 15 of the FCC Rules. These limits are designed to provide reasonable protection against harmful interference in a residential installation. This equipment generates, uses, and can radiate radio frequency energy and, if not installed and used in accordance with the instructions, may cause harmful interference to radio communications. However, there is no guarantee that interference will not occur in a particular installation. If this equipment does cause harmful interference to radio or television reception, which can be determined by turning the equipment off and on, the user is encouraged to try to correct the interference by one or more of the following measures:

- Reorient or relocate the receiving antenna.
- Increase the separation between the equipment and receiver.
- Connect the equipment into an outlet on a circuit different from that to which the receiver is connected.
- Consult the dealer or an experienced technician for help.

FCC warning

Changes or modifications not expressly approved by the party responsible for compliance with the FCC Rules could void the user's authority to operate this equipment.



DHHS and FDA safety certification

This product is made and tested to meet safety standards of the FCC, requirements and compliance with safety performance of the U.S. Department of Health and Human Services, and also with FDA Radiation Performance Standards 21 CFR Subchapter J.

Canada ICES-003 statement

This Class B digital apparatus complies with Canadian ICES-003.

Copyright

© 2008 Rocketfish. Rocketfish and the Rocketfish logo are trademarks of Best Buy Enterprise Services, Inc. Other brands and product names are trademarks or registered trademarks of their respective holders. Specifications and features are subject to change without notice or obligation.

For service and support call 1-800-620-2790.

One-Year Limited Warranty

Rocketfish Products ("Rocketfish") warrants to you, the original purchaser of this new **RF-MSE12** ("Product"), that the Product shall be free of defects in the original manufacture of the material or workmanship for one (1) year from the purchase of the Product ("Warranty Period"). This Product must be purchased from an authorized dealer of Rocketfish brand products and packaged with this warranty statement. This warranty does not cover refurbished Product. If you notify Rocketfish during the Warranty Period of a defect covered by this warranty that requires service, terms of this warranty apply.

How long does the coverage last?

The Warranty Period lasts for one year (365 days), beginning on the date you purchased the Product. The purchase date is printed on the receipt you received with the product.

What does this warranty cover?

During the Warranty Period, if the original manufacture of the material or workmanship of the Product is determined to be defective by an authorized Rocketfish repair center or store personnel, Rocketfish will (at its sole option): (1) repair the Product with new or rebuilt parts; or (2) replace the Product at no charge with new or rebuilt comparable products or parts. Products and parts replaced under this warranty become the property of Rocketfish and are not returned to you. If service of Products and parts are required after the Warranty Period expires, you must pay all labor and parts charges. This warranty lasts as long as you own your Rocketfish Product during the Warranty Period. Warranty coverage terminates if you sell or otherwise transfer the Product.

How to obtain warranty service?

If you purchased the Product at a retail store location, take your original receipt and the Product to the store you purchased it from. Make sure that you place the Product in its original packaging or packaging that provides the same amount of protection as the original packaging. If you purchased the Product from an online web site, mail your original receipt and the Product to the address listed on the web site. Make sure that you put the Product in its original packaging or packaging that provides the same amount of protection as the original packaging.

Where is the warranty valid?

This warranty is valid only to the original purchaser of the Product in the United States, Canada, and Mexico.

What does the warranty not cover?

This warranty does not cover:

- Customer instruction
- Installation
- Set up adjustments
- Cosmetic damage

- Damage due to acts of God, such as lightning strikes
- Accident
- Misuse
- Abuse
- Negligence
- Commercial use
- Modification of any part of the Product, including the antenna

This warranty also does not cover:

- Damage due to incorrect operation or maintenance
- Connection to an incorrect voltage supply
- Attempted repair by anyone other than a facility authorized by Rocketfish to service the Product
- Products sold as is or with all faults
- Consumables, such as fuses or batteries
- Products where the factory applied serial number has been altered or removed

REPAIR REPLACEMENT AS PROVIDED UNDER THIS WARRANTY IS YOUR EXCLUSIVE REMEDY. ROCKETFISH SHALL NOT BE LIABLE FOR ANY INCIDENTAL OR CONSEQUENTIAL DAMAGES FOR THE BREACH OF ANY EXPRESS OR IMPLIED WARRANTY ON THIS PRODUCT, INCLUDING, BUT NOT LIMITED TO, LOST DATA, LOSS OF USE OF YOUR PRODUCT, LOST BUSINESS OR LOST PROFITS. ROCKETFISH PRODUCTS MAKES NO OTHER EXPRESS WARRANTIES WITH RESPECT TO THE PRODUCT, ALL EXPRESS AND IMPLIED WARRANTIES FOR THE PRODUCT, INCLUDING, BUT NOT LIMITED TO, ANY IMPLIED WARRANTIES OF AND CONDITIONS OF MERCHANTABILITY AND FITNESS FOR A PARTICULAR PURPOSE, ARE LIMITED IN DURATION TO THE WARRANTY PERIOD SET FORTH ABOVE AND NO WARRANTIES, WHETHER EXPRESS OR IMPLIED, WILL APPLY AFTER THE WARRANTY PERIOD. SOME STATES, PROVINCES AND JURISDICTIONS DO NOT ALLOW LIMITATIONS ON HOW LONG AN IMPLIED WARRANTY LASTS, SO THE ABOVE LIMITATION MAY NOT APPLY TO YOU. THIS WARRANTY GIVES YOU SPECIFIC LEGAL RIGHTS, AND YOU MAY ALSO HAVE OTHER RIGHTS, WHICH VARY FROM STATE TO STATE OR PROVINCE TO PROVINCE.

Contact Rocketfish:

For customer service please call 1-800-620-2790
www.rocketfishproducts.com

Distributed by Best Buy Purchasing, LLC
 7601 Penn Avenue South, Richfield, Minnesota, U.S.A. 55423-3645
 © 2008 Best Buy Enterprise Services, Inc.

All rights reserved. ROCKETFISH is a trademark of Best Buy Enterprise Services, Inc. Registered in some countries. All other products and brand names are trademarks of their respective owners.

www.rocketfishproducts.com (800) 620-2790

Distributed by Best Buy Purchasing, LLC

7601 Penn Avenue South, Richfield, MN 55423-3645 USA

© 2008 Best Buy Enterprise Services, Inc.

All rights reserved. ROCKETFISH is a trademark of Best Buy Enterprise Services, Inc.

All other products and brand names are trademarks of their respective owners.



ENGLISH
08-1729